

Part No.: UT-3398-S-04-X

seal
 1-cable OD:7.1-9mm
 2-cable OD:4-7mm
 3-cable OD:9.1-10.5mm

REV.	Description	Date
1	spec. revise	2012/5/28
2	upgrade drawing	2014/2/27
3	coupling ring dimension revise	2019/4/17

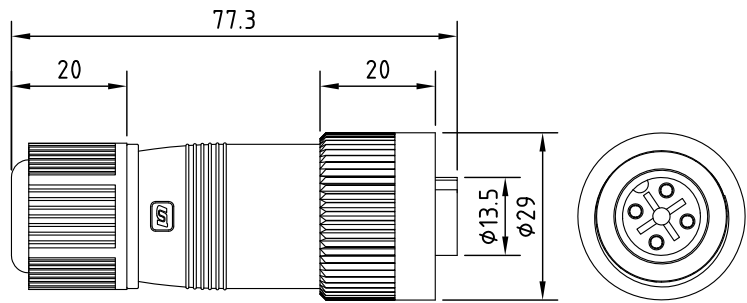
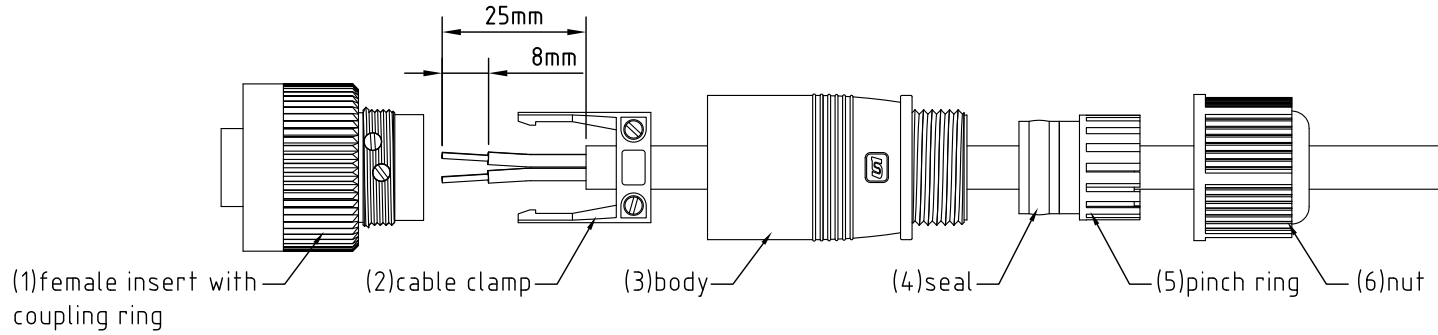

RoHS

Specification

General Characteristics

Locking system: Screw
 Termination: Screw
 Shell protection: IP67
 Wire gauge: 20-14

Electrical Characteristics

Rated Current: 16A
 Contact Resistance: <10mΩ
 Insulation Resistance: >10MΩ

7	terminal	gold plated brass	4
6	nut	PA (UL 94V-0)	1
5	pinch ring	PA (UL 94V-0)	1
4	seal	TPR	1
3	body	PA (UL 94V-0)	1
2	cable clamp	PA (UL 94V-0)/SUS	1
1	female insert	PA (UL 94V-0)	1
Item	Description	Material	Q'TY



Unicable Co., Ltd. 國陽電業有限公司

5F., No. 111-33, Sec. 4, San Ho Road., San Chung Dist., New Taipei City, Taiwan
<http://www.unicable.com.tw> TEL:+886-2-2286-2122 FAX:+886-2-2286-1010

DATE	2019/4/17	PART NO.	UT-3398-S-04
DWN	GINA	REV.	3
CHK			
UNIT	MM		

ITEM In-Field Installable Circular Connector